

# X-TERRA VOYAGER

METAL DETECTOR

## USER MANUAL



# Contents

# Quick Start

QUICK START .....	2
PARTS OVERVIEW .....	3
ASSEMBLY .....	4
CONTROLS .....	6
DISPLAY .....	7
SEARCH MODES .....	8
All Metal .....	8
Custom .....	8
Jewelry .....	8
Learn .....	8
OPERATION .....	9
DETECTOR SETTINGS .....	10
Volume .....	10
Backlight .....	10
Sensitivity .....	10
To Adjust the Sensitivity Level .....	10
Excessive Noise .....	10
PINPOINT .....	11
Locate a Target With Pinpoint .....	11
DEPTH GAUGE .....	12
TARGET IDENTIFICATION .....	13
Target Identification Number .....	13
Target Groups .....	13
Target Examples .....	13
Target Tones .....	14
BATTERIES .....	15
Battery Level .....	15
DETECTOR CARE AND SAFETY .....	16
TROUBLESHOOTING .....	17
TECHNICAL SPECIFICATIONS .....	18
COMPLIANCE .....	19

## 1. Turn On

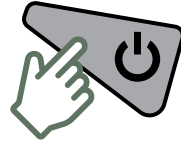

## 2. Wait For 5 Seconds



## 3. Begin Detecting

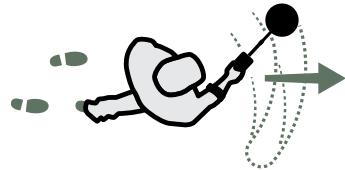

# Parts Overview

## 1. CONTROL POD

- 2. Speaker
- 3. Coil Connector Socket
- 4. Battery Compartment
- 5. Battery Cover
- 6. Headphone Socket – 1/8" (3.5 mm)

## 7. WIRED HEADPHONES

## 8. HANDLE ASSEMBLY

- 9. Locating Hook
- 10. Control Pod Screw
- 11. Camlock
- 12. Handgrip
- 13. Armrest Adjustment Camlock
- 14. Upper Shaft
- 15. Armrest with Stand

## 16. MIDDLE SHAFT

- 17. Camlock

## 18. LOWER SHAFT

- 19. Rubber Washers (x2)
- 20. Coil Nut & Bolt

## 21. COIL

- 22. Skidplate
- 23. Yoke Bracket
- 24. Coil Cable
- 25. Coil Connector
- 26. Retaining Ring

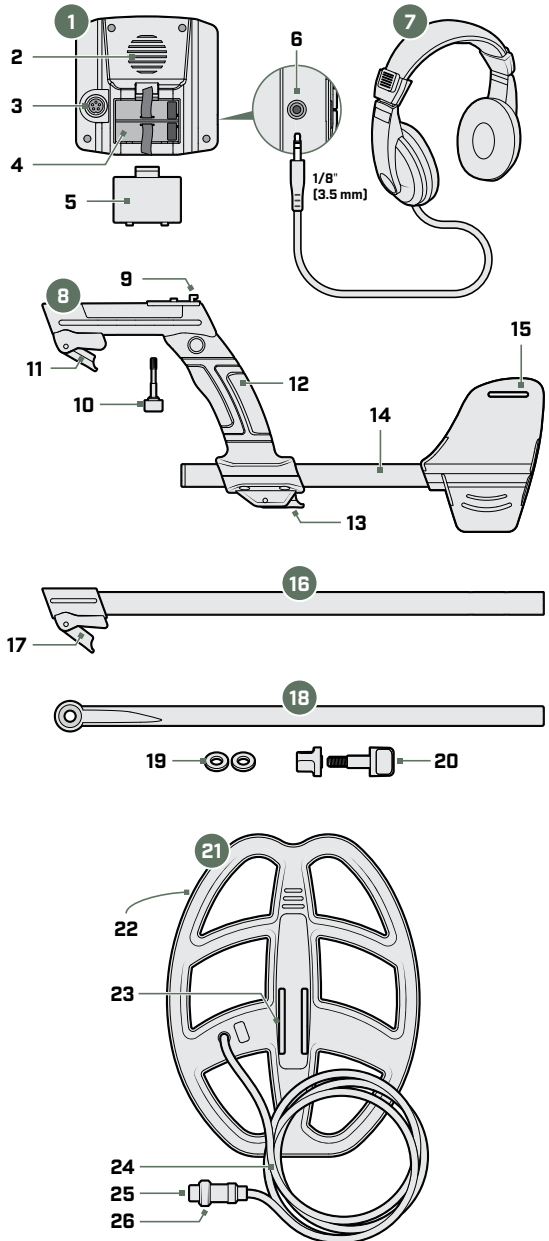

# Assembly

## ATTACH THE CONTROL POD

1. Place the Control Pod on the Locating Hook on the top of the Handle.
2. Secure with the Control Pod Screw.

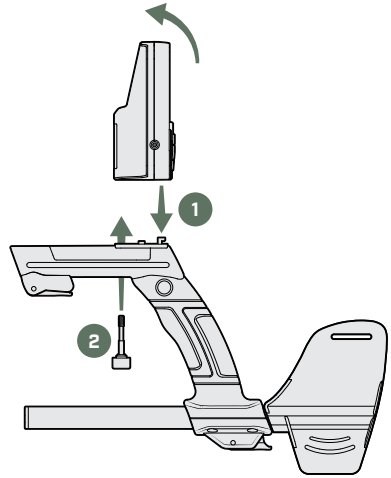

## ASSEMBLE THE SHAFTS

3. Open the Camlocks.
4. Insert the Middle Shaft into the Handle Assembly, and insert the Lower Shaft into the Middle Shaft.
5. Close the Camlocks.

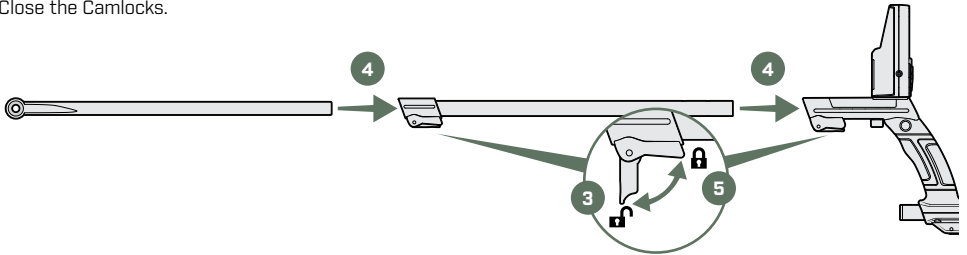

## ATTACH THE COIL

6. Check that the Rubber Washers are inserted into the Lower Shaft.
7. Slide the Lower Shaft into the Yoke Bracket on the Coil, aligning the holes. Fasten with the supplied plastic Bolt and Nut.

**CAUTION:** Do not use tools to tighten – over-tightening may cause damage.

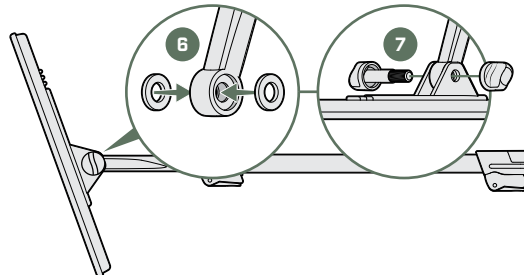

# Assembly *(Continued)*

## WRAP THE CABLE AND PLUG-IN

**8.** Wrap the Coil Cable around the Shaft enough times to take up the slack, but so that the Coil can still tilt easily.

**9.** Align the Coil Connector with the socket on the back of the Control Pod. Plug it in, then tighten the Retaining Ring.

**CAUTION:** Do not use tools to tighten the Retaining Ring — over-tightening may cause damage.

**CAUTION:** Do not force the connector if there is resistance — this may cause damage.

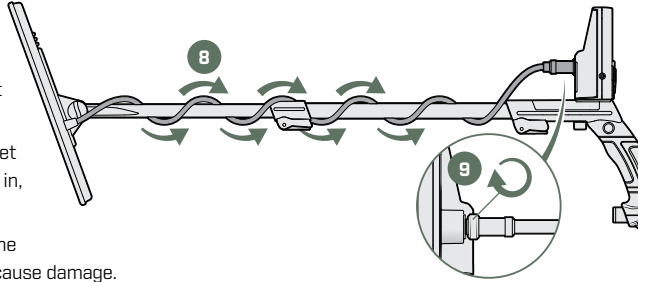

## ADJUST THE DETECTOR LENGTH

**10.** Open the Armrest Adjustment Camlock.

**11.** Rest your arm in the Armrest and adjust as needed — the armrest should be positioned just below your elbow.

**12.** Close the Camlock.

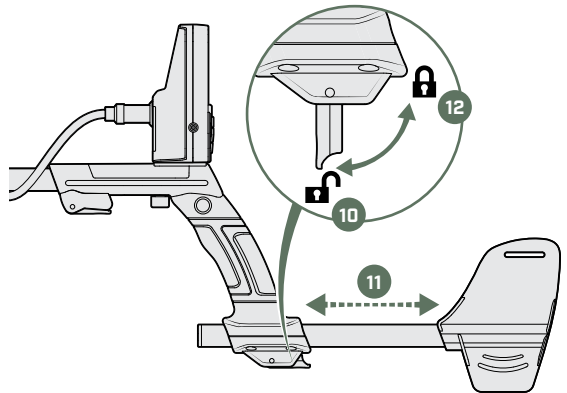

## INSERT BATTERIES

**13.** Remove the Battery Cover.

**14.** Connect two 9V alkaline batteries to the battery terminals. Make sure the terminals are aligned correctly to the polarity symbols (+ and -).

**15.** Replace the Battery Cover.

**CAUTION:** Turn off the detector before changing the batteries.

See page 15 for additional important information about batteries.

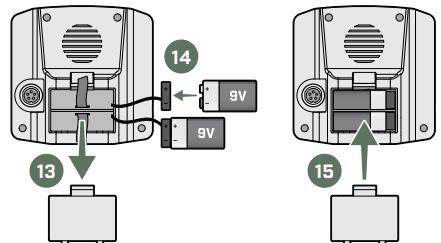

# Controls

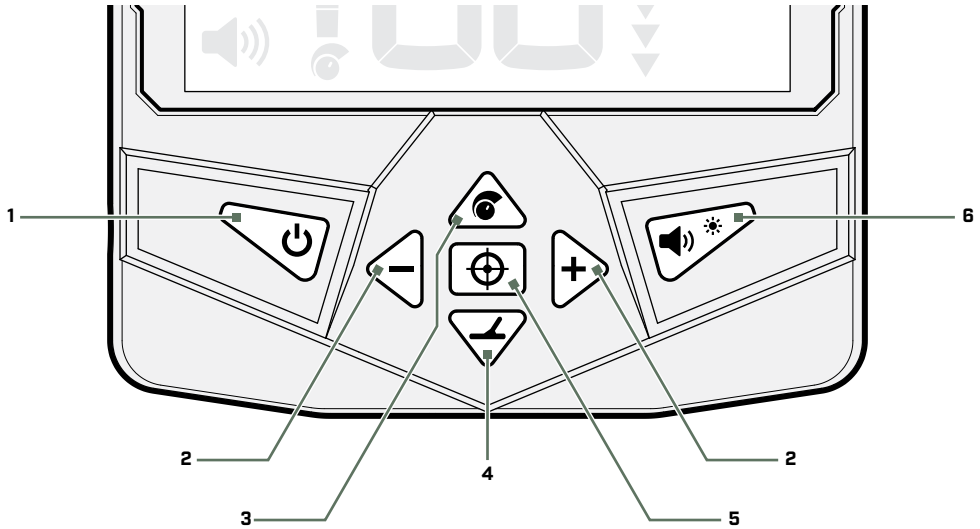

## 1. POWER ON/OFF

Turns the detector On and Off.

## 2. MINUS (-) / PLUS (+)

Adjusts the sensitivity level (when sensitivity adjustment is enabled) (page 10).

Press when editing the Custom Search Mode to turn a Target Group On or Off (page 8).

## 3. ENABLE SENSITIVITY ADJUSTMENT

Press to enable sensitivity adjustment (then press - and + to adjust). To disable sensitivity adjustment, press the button again, or wait 3 seconds and it will automatically time-out.

## 4. SEARCH MODE

Selects the next available Search Mode (page 8).

## 5. PINPOINT

Press-and-hold to use Pinpoint Mode to accurately locate a detected target (page 11).

## 6. VOLUME ADJUST

Adjusts the audio Volume Level, cycling from low-to-high (page 10).

Long-press to turn the LCD backlight On and Off.

**Note:** The detector turns Off automatically if no button is pressed or no target is detected within 15 minutes.

# Display

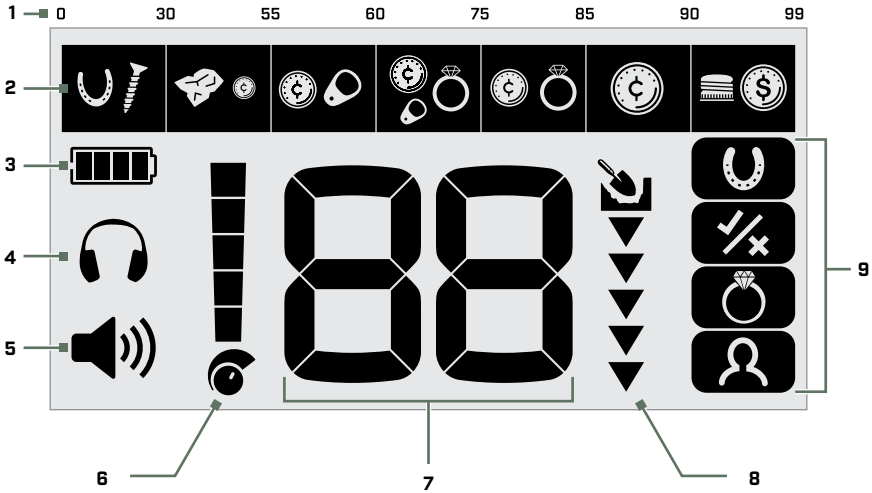

## 1. TARGET ID REFERENCE

A reference guide indicating the types of targets that can be found for the corresponding Target Group.

## 2. TARGET GROUPS

Represents groupings of Target Identification Numbers. The icon shows the types of targets typically found at that position on the Target ID scale [page 13]. The Target Groups align with the Target ID Reference above them.

## 3. BATTERY LEVEL

Indicates the current battery level [page 15].

## 4. HEADPHONES INDICATOR

Indicates when headphones are connected.

## 5. VOLUME LEVEL

Displays the detector audio volume [page 10].

## 6. SENSITIVITY LEVEL

Displays the Sensitivity level [page 10].

## 7. TARGET IDENTIFICATION NUMBER

Displays the numerical value of a detected target, giving you a good chance of identifying an object before you dig. The number is assigned based on the metallic composition of a target, with ferrous metals being assigned low ID's ranging from 0 to 30, and non-ferrous metals being assigned higher ID's ranging from 31 to 99.

For example, a US quarter will always display the same Target Identification (ID) Number (86).

## 8. DEPTH GAUGE

Shows the approximate depth of a detected target [page 12].

## 9. SEARCH MODES

Displays the active Search Mode [page 8].

There are four Search Modes; All Metal, Custom, Jewelry and Learn.

# Search Modes

VOYAGER has four Search Modes that are best suited for finding different types of metal objects.

Press the Search Mode button  to cycle through the Search Modes.



## ALL METAL

**Find all targets that contain metal, including iron.**

Detecting in All-Metal mode guarantees you will not miss any targets.



## JEWELRY

**Find jewelry such as rings, bracelets and necklaces.**





Jewelry mode can also find coins, relics and other non-jewelry items. This mode ignores iron therefore most nails and small iron pieces will not be detected, making this a good mode for high-trash locations.



## CUSTOM

**Choose which groups of Target IDs will be detected.**

This helps you find specific groups of object whilst ignoring others; this can be very useful in trashy locations to ignore trash, or for finding specific targets.

1. Press the Search Mode button  until Custom mode is selected.
2. Press the Minus and Plus buttons   to navigate to the Target Group you want change. The icon will flash for 3 seconds and then change to the reverse status. Alternatively, you can press the Search Mode button  while the icon is flashing to toggle the Group On or Off.

The example shows the first, second, and fourth Groups turned Off (not detected) so that less iron, trash and pull tabs will be detected.

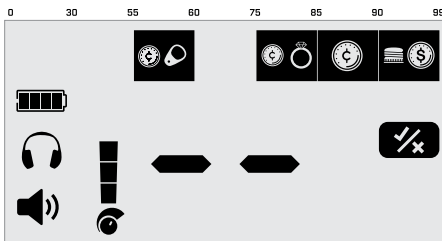

## LEARN

**Find a specific target.** This mode is designed to 'learn' a metal target so that you only find that type of object.

1. Have the target ready that you want the VOYAGER to learn – this example uses a coin.
2. Press the Search Mode button  until Learn mode is selected.
3. Wave the coin over the Coil. The detector will learn the metallic properties of that exact coin and will turn all Target Groups Off except for the Group that the coin belongs to.

The example shows Learn mode for a US Quarter. A US Quarter has a Target ID number of 86, therefore only that Target Group is turned On (detected).

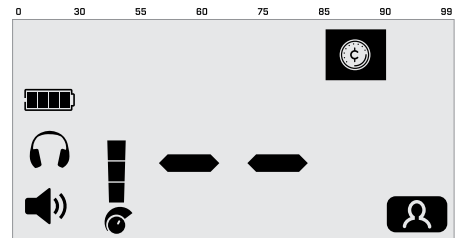





# Operation

These steps go beyond Quick Start and explain how to successfully operate your detector from turning on to recovering a target.

## 1. TURN ON AND SELECT A SEARCH MODE

Press the Power button  to turn the detector On, waiting a few seconds for the start-up calibration to complete.

Press the Search Mode button  to select the Search mode that best suits what you want to detect – this would normally be Jewelry or All Metal mode.

## 2. BEGIN DETECTING

The detector coil does not detect metal when it is stationary – keep the coil moving.

**Sweep the coil close and parallel to the ground.**

Avoid touching the ground or bumping the coil. This will maximize detection depth and improve the response to small objects.

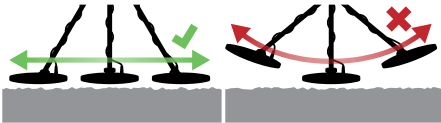

Sweep the coil over the ground in a side-to-side motion while slowly walking forward at the end of each sweep. An average sweep speed is 2 to 3 seconds from right-to-left-to right.

**Slightly overlap the previous sweep to ensure full ground coverage.**

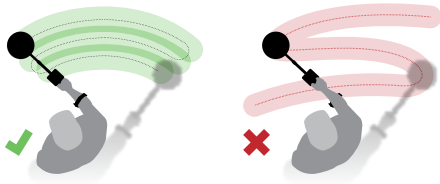

## 3. DETECT A TARGET

When a target is detected, the detector beeps and the display shows a Target ID number. The corresponding Target group icon will also flash, indicating the possible type of object you have found.

The Depth Gauge (page 12) on the Display will show the approximate depth of the buried target, giving you an idea of how deep to dig.

## 4. PINPOINT A TARGET

Once you have detected a target that you want to dig, use the Pinpoint function to narrow down the exact location of the target. This is so that you can dig a smaller hole, making target recovery faster and neater. Follow the steps in “Locate a Target With Pinpoint” on page 11.

## 5. RECOVER THE TARGET

Carefully dig the target, taking care not to damage it with your digging tool.

Once you have recovered the target, check the hole once more in case there are still targets present.

## 6. FILL THE HOLE

Always fill your hole when you are finished digging.

## FACTORS THAT AFFECT DETECTING

Sometimes detection accuracy can be affected by the following factors:

- The angle of the target buried in the soil.
- The depth of the target.
- The level of oxidization/rustiness of the target.
- The size of the target.
- Electrical interference in the environment.

In highly mineralized ground, fertile ground or wet sand, the detector could sound even if there is no metal. In this case, you can decrease the sensitivity or lift the search coil higher above the ground.

Metallic digging tools will also affect the detection if they are near the search coil. It's better to place them a little farther away.

# Detector Settings

## VOLUME

The Volume setting changes the loudness of target signals.

Press the Volume button to cycle through the volume settings from low to high. Once maximum Volume is reached, pressing the Volume button will return to the lowest Volume Level.



The Volume/Backlight button

The Volume Level indicator on the display shows the current Volume Level. Each bar represents one level.



The Volume Level indicator

## BACKLIGHT

The VOYAGER has a backlight for detecting in low-light situations. The backlight is turned Off by default at each start-up to reduce battery consumption.

Long-press the Volume/Backlight button to turn the backlight On or Off.



The Volume/Backlight button

**NOTE:** Turn the backlight Off when it is not needed, to conserve battery life.

## SENSITIVITY

The VOYAGER detector is highly sensitive and has adjustable sensitivity. Setting the correct sensitivity level for individual detecting conditions will maximize detection depth.



Always choose the highest stable Sensitivity setting to ensure optimum performance.

The Sensitivity Level indicator on the display shows the current Sensitivity Level. Each bar represents one level.



The Sensitivity Level indicator

## To Adjust the Sensitivity Level

1. Hold the coil stationary, then press the Sensitivity button  to enable sensitivity adjustment. Note, sensitivity adjustment will time-out after 3 seconds of inactivity.
2. Press the Plus button  to increase the sensitivity until false signals begin to occur.
3. Press the Minus  button to reduce the sensitivity just enough that the false signals disappear.
4. Sweep the coil over a clear patch of ground, and reduce the sensitivity level more if there is still ground noise.

## Excessive Noise

Sometimes, excessive noise is encountered whilst detecting. This can be caused by environmental electrical interference from sources such as power lines, mobile phone towers, or other metal detectors.

If noise is a problem, try the following steps in order until the noise is eliminated.

1. Move away from local sources of electrical Interference.
2. Restart the detector.
3. If restarting the detector does not eliminate the excessive noise, then try reducing the Sensitivity Level.

# Pinpoint

Pinpointing helps you to quickly narrow down the location of a buried target, allowing you to determine its exact location before digging.

While Pinpoint is active the detector will play a sound while the Search Coil is stationary over a target.

## LOCATE A TARGET WITH PINPOINT

1. Hold the coil away from the approximate target location, then press-and-hold the Pinpoint button to enable Pinpoint. The Target ID number will begin to flash 'PP'. Wait for 'PP' to stop flashing.



The Pinpoint button

2. Sweep the coil slowly over the target location.
3. Locate the center of the target by listening for the loudest signal.
4. Rotate the Search Coil by stepping to the side of the target. Repeat steps 2 and 3.
5. The Target will be located where the loudest signal sounded.
6. Release the Pinpoint button and return to normal detecting.

# Depth Gauge

The Depth Gauge indicates the approximate depth of a detected target.

The Depth Gauge is a guide only. Fewer arrows indicate a shallower target, more arrows indicate a deeper target. The accuracy can vary depending on the target type and size, and ground conditions.

After a target is detected, the Depth Gauge will remain on the LCD for up to 5 seconds, or until the next target is detected.

When there is no detection, the Depth Gauge icon and arrows are turned Off.

Here is an example of the Depth Gauge reading and the approximate target depth for a US quarter.

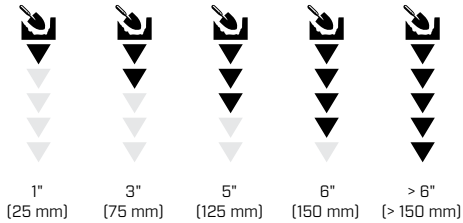

# Target Identification

## TARGET IDENTIFICATION NUMBER

Target Identification (Target ID) numbers range from 0 to 99 with ferrous (iron) targets ranging from 0 to 30.

When a target is detected, it is represented as a number that appears on the Target ID field on the display. This indicates the target's ferrous or non-ferrous properties for quick and easy identification.

For example, a US quarter has a Target ID of 86. This means that each time a Target with an ID of 86 is detected, there is a good chance that it will be a US quarter.

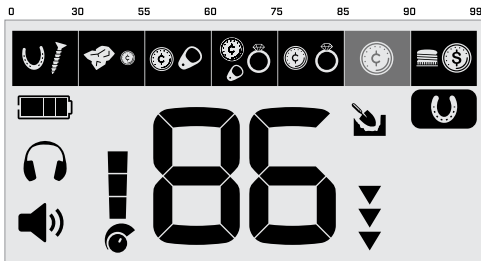

The last detected Target ID remains on the display for 5 seconds or until another target is detected.

If there is no detection, or the detector passes over a target that it rejects, the display shows two large dashes.

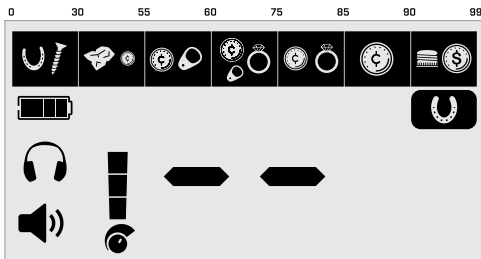







## TARGET GROUPS

Target Groups are located along top of the Display.

Each Target Identification Number has a corresponding Target Group icon that will flash when that type of target is detected.

### Target Examples

Targets have a wide variety of metallic properties, therefore no target can be identified for certain. This table is a guide only.

ID Range	Types of Targets
 1-30	Iron
 31-55	Small coins, fine jewelry, foil, US 5¢
 56-60	Mid-sized coins, pull tabs
 61-75	Mid-sized coins, jewelry, US 1¢, pull tabs
 76-85	Mid-sized coins, jewelry, US 10¢
 86-90	Large coins, silver coins, US 25¢
 91-99	Bottlecaps, large coins, silver coins, US 50¢

# Target Identification *(Continued)*

## TARGET TONES

Groups of Target IDs are assigned Target Tones of different pitch so that the operator can broadly classify the Target ID without having to look at the display.

VOYAGER has three Target Tones: Low, Mid, and High.

The tone break position is the point on the Target ID scale at which the Target Tone changes from one pitch to another.



VOYAGER target tones

# Batteries

Two 9V batteries are needed to power the VOYAGER.  
Using alkaline batteries is recommended.

Replace the batteries when there are no segments remaining on the Battery Level indicator.



Batteries need replacing

**NOTE:** Replace both batteries with fresh ones at the same time — do not mix old and new batteries.

**NOTICE:** Dispose of old batteries properly. Never bury or burn them.

**NOTICE:** If not using the detector for a week or longer, remove the batteries. Batteries can leak chemicals that can destroy electronic parts, so do not store the detector for long periods of time with batteries in it.

## BATTERY LEVEL

The Battery Level indicator shows the current battery level. The Battery Level Indicator is approximate only.

When the battery level is critically low, the detector will automatically shut-down.



The Battery Level indicator

# Detector Care and Safety

- Wash your hands before handling the detector after applying sunscreen or insect repellents.
- Do not use solvents to clean. Use a damp cloth with a mild soap detergent.
- Never allow the detector to come into contact with gasoline/petrol or other petroleum-based liquids.
- Avoid getting sand and grit in the shafts and fastenings (e.g. coil yoke assembly and camlocks). If sand and grit accumulates in these parts they should be wiped clean with a damp cloth.
- Do not bring the detector or accessories into contact with sharp objects as this may cause scratches and damage.
- If the shafts become noticeably scratched, wipe them thoroughly with a damp cloth.
- Do not leave the detector in excessive cold or heat longer than necessary. Covering it when not in use will help protect it. Avoid leaving it in a hot vehicle.
- Ensure the coil cable is in good condition and not subject to undue stress.
- Take precautions when transporting or storing the detector. Although the detector is constructed from the highest quality materials and has undergone rigorous durability tests, the display screen could be prone to scratching or serious damage if not treated with due care.
- Do not expose the detector to extreme temperature conditions. The storage temperature range is from -20°C to +70°C (-4°F to +158°F).
- Do not expose accessories not listed as waterproof to liquid/moisture or excessive humidity.
- Do not allow children to play with the detector or accessories; small parts are a choking hazard.
- Remove batteries prior to air transportation or for storage periods longer than one week.



# Troubleshooting

## Detector does not turn on, or turns off by itself

1. Replace the batteries.

## Detector does not detect anything

1. Check if Target Groups are turned on for the objects you are detecting, or select All Metal mode.
2. Make sure you are sweeping the coil close enough to the ground (i.e. make sure the coil is close enough to the target to detect it).
3. Ensure that the Search Coil is connected properly.
4. Increase the Sensitivity level (page 10).

## Erratic/excessive noise

1. Restart the detector and check for noise again.
2. Move away from local sources of electrical interference.
3. Reduce the Sensitivity level (page 10).

## Multiple Target Groups are flashing, and there are lots of beeps

1. You may be detecting multiple different targets at the same time (overlapping objects).
2. The detected object is complex (rusty or made of multiple types of metal), so the detector is unable to properly identify it. Try approaching the target from different angles, or try using a different Search mode.

## No sound when headphones are connected

1. Check that the headphones are plugged in.
2. Check that detector Volume is set to an audible level.
3. If using headphones that have their own volume control, check that it is set to an audible level.
4. Unplug the headphones and confirm that the detector speaker is audible.
5. If available, try using a different set of headphones.

# Technical Specifications

<b>Search Modes</b>	All Metal, Custom, Jewelry, Learn
<b>Operating Frequency</b>	5.82 kHz
<b>Sensitivity</b>	5 levels
<b>Volume</b>	3 levels
<b>Target Tones</b>	3 tones (Low, Mid, High)
<b>Discrimination Segments</b>	7 segments
<b>Pinpoint Mode</b>	Yes
<b>Target ID's</b>	0 to 99
<b>Depth Gauge</b>	5 levels
<b>Length</b>	Extended: 55 in (140 cm)    Collapsed: 28.3 in (72 cm)
<b>Weight</b> (excluding batteries)	2.8 lbs (1.3 kg)
<b>Display</b>	Monochrome LCD
<b>Supplied Coil</b>	11" x 8.5" Double-D
<b>Audio Output</b>	In-built loudspeaker, Wired 3.5 mm (1/8") headphones
<b>Additional Included Accessories</b>	Collapsible Digger, Backpack, Wired 3.5 mm (1/8") headphones, 2x 9V Batteries
<b>Waterproof</b>	Coil waterproof to 3.3 ft (1 m)
<b>Operating Temperature Range</b>	-10°C to +40°C (+14°F to +104°F)
<b>Storage Temperature Range</b>	-20°C to +70°C (-4°F to +158°F)

Equipment may vary according to the model or items ordered with your detector. Minelab reserves the right to respond to ongoing technical progress by introducing changes in design, equipment and technical features at any time. For the most up-to-date specifications for your VOYAGER detector, visit [www.minelab.com](http://www.minelab.com)

# Compliance

## FEDERAL COMMUNICATIONS COMMISSION (FCC) STATEMENT

**This device complies with part 15 of the FCC Rules.**

Operation is subject to the following two conditions:

- (1) This device may not cause harmful interference, and
- (2) this device must accept any interference received, including interference that may cause undesired operation.

**US Responsible Party:** MINELAB AMERICAS INC, 123 Ambassador Drive, Suite 123, Naperville, IL 60540, USA  
ComplianceManager@minelab.com.au

## WASTE ELECTRICAL AND ELECTRONIC EQUIPMENT RECYCLING (WEEE)



This symbol indicates that the equipment and its electrical accessories should not be disposed of as household garbage. These items should not be disposed of as unsorted municipal waste and should be taken to a certified collection point for recycling and proper disposal. Refer 2012/19/EU (Waste Electrical and Electronic Equipment).

## SIMPLIFIED EU & UKCA DECLARATION OF CONFORMITY

Hereby, Minelab Electronics Pty Ltd declares that the radio equipment type [Refer to equipment listed in Table 1] complies with Directive 2014/53/EU and The Radio Equipment Regulations 2017 [S.I. 2017/1206]. Full text of the EU & UKCA declarations of conformity are available at the following internet address: [www.minelab.com/compliance](http://www.minelab.com/compliance)

## UPROSZCZONA DEKLARACJA ZGODNOŚCI UE

Niniejszym firma Minelab Electronics Pty Ltd deklaruje, że typ urządzenia radiowego [patrz urządzenia wymienione w tabeli 1] jest zgodny z dyrektywą 2014/53/UE. Pełny tekst deklaracji zgodności UE jest dostępny pod następującym adresem internetowym: [www.minelab.com/compliance](http://www.minelab.com/compliance)

Table | Tabeli 1



VOYAGER

5.82 kHz

< -30 dBm

This work is licensed under the Creative Commons Attribution-NonCommercial-NoDerivatives 4.0 International (CC BY-NC-ND 4.0) International License.

To view a copy of this license, visit: <http://creativecommons.org/licenses/by-nc-nd/4.0/>





[www.minelab.com](http://www.minelab.com)

4901-0512-2